



GREEN LAKE COUNTY

571 County Road A, Green Lake, WI 54941

Post Date: 2/1/2024

**The following documents are included in the packet for the
Parks Commission Committee Meeting on February 5, 2024:**

- 1) Agenda
- 2) Minutes: 10/09/2023
- 3) Ordinance 187-19 Use of Launch Fee Revenue
- 4) Kayak Launch Estimates
- 5) Parks Report



GREEN LAKE COUNTY OFFICE OF THE COUNTY CLERK

Elizabeth Otto
County Clerk

Office: 920-294-4005
FAX: 920-294-4009

Parks Commission Meeting Notice

Date: Monday, February 5, 2024 Time: 3:00 PM

Location: Government Center, County Board Room, 571 County Road A, Green Lake WI

AGENDA

Committee Members

William Boutwell, Chair
Curt Talma, Vice- Chair
VACANT
Charlie Wielgosh
Ken Bates
Vonn Roberts
Michael Shattuck

Elizabeth Otto, Secretary

Virtual attendance at meetings is optional. If technical difficulties arise, there may be instances when remote access may be compromised. If there is a quorum attending in person, the meeting will proceed as scheduled.

1. Call to Order
2. Certification of Open Meeting Law
3. Pledge of Allegiance
4. Approval of Minutes: 10/09/2023
5. Public Comment (3 minute limit)
6. Appearance
 - Sean Kollmer, Green Lake County Association - USGS Samples
 - Lisa Meier, Green Lake Chamber of Commerce - Request for Kiosk
7. Discussion and Approval of the USGS Sample Request
8. Discussion and Approval of the Joint Kiosk Between the County Parks and the Green Lake Chamber of Commerce.
9. Boat Launch Fee Update
 - Ordinance to Approve Changing the use of Boat Launch Fees
10. Kayak Launch Estimates – Discussion and Take Action
11. Parks Report
 - Discuss Projects for 5 Year Plan
 - Monthly Activities
12. Committee Discussion
 - Discuss and Set Goals for Parks for the Future
 - Future Meeting Dates: Possibly March 15, 2024
13. Adjourn

This meeting will be conducted through in person attendance or audio/visual communication. Remote access can be obtained through the following link:

Microsoft Teams meeting

Join on your computer, mobile app or room device

[Click here to join the meeting](#)

Meeting ID: 220 477 701 055

Passcode: dpVBhq

[Download Teams](#) | [Join on the web](#)

Or call in (audio only)

[+1 920-515-0745,,971765971#](#) United States, Green Bay

Phone Conference ID: 971 765 971#

[Find a local number](#) | [Reset PIN](#)

Please accept at your earliest convenience. Thank you!

[Learn More](#) | [Help](#) | [Meeting options](#) | [Legal](#)

Please note: Meeting area is accessible to the physically disabled. Anyone planning to attend who needs visual or audio assistance, should contact the County Clerk's Office, 294-4005, not later than 3 days before date of the meeting.

PARKS COMMISSION

October 9, 2023

The regular meeting of the Parks Commission was called to order by Chair Bill Boutwell on Monday, October 9, 2023 at 3:00 PM in the Green Lake County Board Room, Green Lake County Government Center, 571 County Road A, Green Lake, WI. The meeting was held both in person and via remote access. Requirements of the open meeting law were certified as being met. The pledge of allegiance was recited.

Present: Bill Boutwell
Vonn Roberts
Charlie Wielgosh
Michael Shattuck
Curt Talma (remote)

Absent: Ken Bates

Other County Employees Present: Liz Otto, County Clerk; Cate Wylie, County Administrator; Jeff Mann, Corporation Counsel; Ron Severson, Maintenance Technician; Todd Morris, County Conservationist

APPROVAL OF MINUTES

Motion/second (Roberts/Shattuck) to approve the minutes of the September 11, 2023 with no changes or corrections. Motion carried with no negative vote.

PUBLIC COMMENT

Jerry Krueger of Markesan asked why the boat launches are pulled out so early and also questioned why the docks aren't permanent.

APPEARANCE: TODD MORRIS

Todd Morris, County Conservationist, gave an update on the boat wash station at Dodge Memorial Park. A meeting was held with the Green Lake Association and changes for next year will include automation instead of all manned hours, heat installed for longer season availability, less staffing hours to save money and the addition of a camera at the site. The signage will also be moved for better flow of information. No additional funding requested.

BOAT LAUNCH FEE UPDATE

Clerk Otto stated that currently \$55,405 has been taken in this year for boat launch fees. A detailed report will be provided for November with expenses and revenues along with carryover.

KAYAK LAUNCH UPDATE

Two quotes requested – Scott Weir not here. No updates at this time per County Administrator Cate Wylie. Discussion held regarding signage by the kayak launch to pay launch fee at the station. Motion Roberts to evaluate the cost of signage. Corporation Counsel Jeff Mann advised no motion is needed to have Scott Weir look into the cost of signage. Discussion for next month to discuss a possible boat launch fee for kayak launch usage.

UPDATE ON LAND ASSESSMENT

No update per Cate Wylie.

PARKS REPORT

- **Monthly activities** – no discussion on submitted report from Scott Weir

COMMITTEE DISCUSSION

Future Meeting Date: November 6th at 3:00 PM

Future Agenda items for action & discussion: land acquisition, kayak launch fees, barge situation on Green Lake, boat launch enforcement, pier installation and removal dates

ADJOURNMENT

Chair Boutwell adjourned the meeting at 3:16 PM.

Submitted by,

Liz Otto
County Clerk

DRAFT

Green Lake County, WI
Thursday, February 1, 2024

Chapter 187. Parks and Recreation

Article IV. Boat Launch User Fees

[Adopted 9-17-2009 by Ord. No. 962-2009; amended in its entirety 5-18-2010 by Ord. No. 979-2010]

§ 187-11. Permit required to use boat launch.

[Amended 4-17-2018 by Ord. No. 15-2018; 3-19-2019 by Ord. No. 6-2019]

No person shall use any County of Green Lake County-owned or -operated boat launch facility for launching purposes without an annual or daily launching permit. The annual permit shall be valid from April 1 of the year of issuance to March 31 of the next year. The daily permit shall only be valid during the day of purchase. Daily permits will be sold through self-registration at each boat launch site. Annual permits will be sold at the County Clerk's office and all establishments approved by the Parks Commission. Boat launch sites include Margaret Dodge Memorial Park and Sunset Park.

§ 187-12. Fees; display of permit.

[Amended 3-19-2019 by Ord. No. 6-2019]

- A. The annual permit fee shall be \$30 for residents and \$40 for nonresidents. "Resident" for the purposes of this article shall mean a resident of the County.
- B. The daily permit fee shall be \$7.
- C. A "boat launch" is defined as the use of the launch facility for the placement of one boat into the water and for the retrieval of the boat from the water to a trailer or device used to remove the boat from the water.
- D. All annual permits shall be prominently placed and displayed on the interior of the driver's side windshield of the vehicle used to transport the boat to the launching area.

§ 187-13. Exemptions.

Any person who shall violate any parking restriction under Chapter 187 shall forfeit \$50 for each violation, plus, if applicable, the costs of removal and storage of the vehicle.

- A. If the \$50 prescribed above is not paid within 10 days after the citation was issued, and the citation is not contested, the forfeiture shall increase to \$100.
- B. If the \$100 is not paid within 20 days of the citation, collection action for the forfeiture or proceedings to suspend the vehicle owner's registration as provided for in W.S.A. § 345.28 will be commenced, and an additional administrative fee of \$50 shall be added to the forfeiture amount, bringing the total due to \$150.

§ 187-19. Use of Launch Fee Revenue.

The net revenue resulting from the sale and enforcement of launch fee permits shall be used to establish, maintain and improve boat launch facilities within the County of Green Lake. (NR 1.91, Wis. Admin. Code).



PRODUCT SPECIFICATION GUIDE

2022

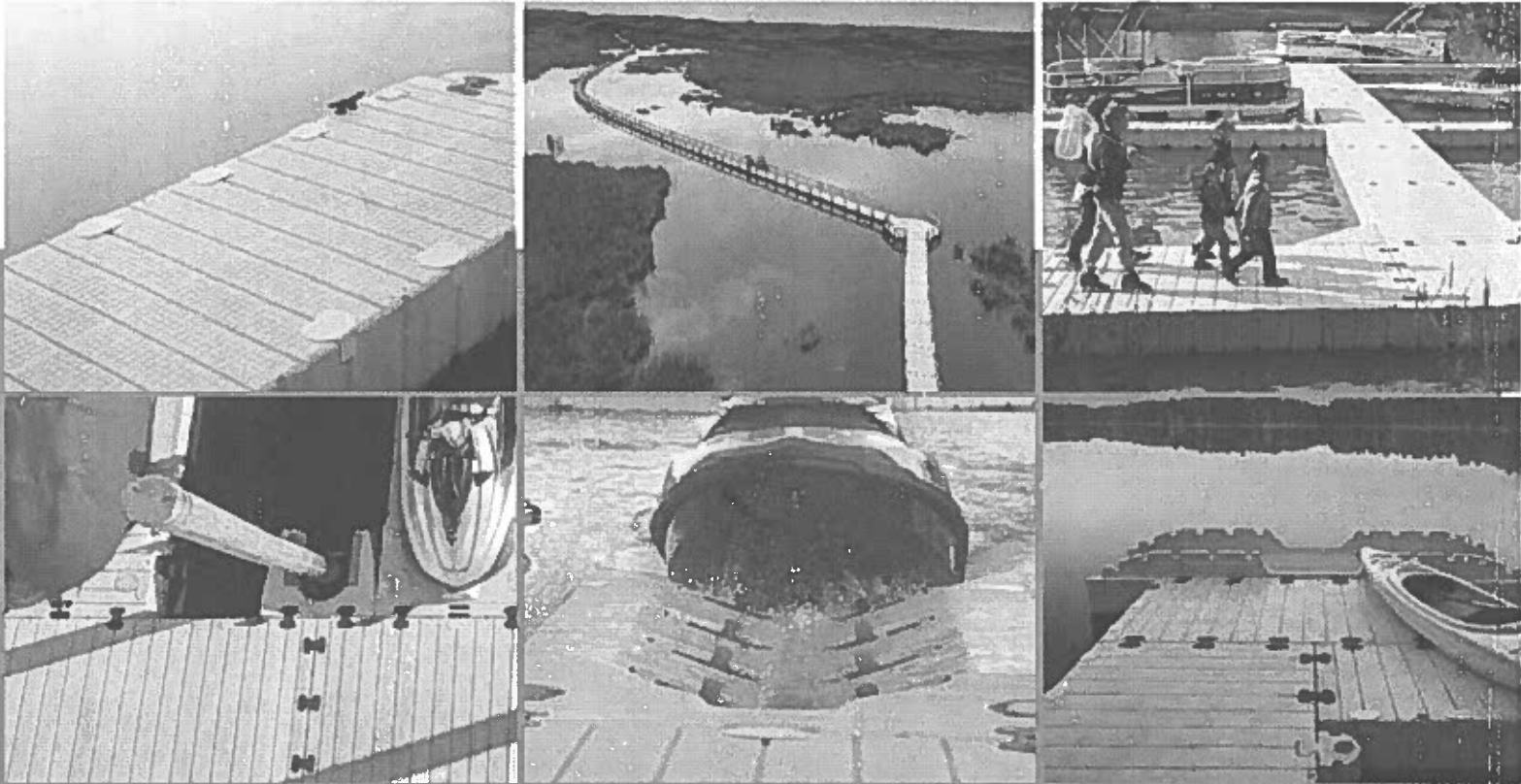

Low Maintenance and Barefoot Friendly

- EZ Dock polyethylene docks are durable and slip resistant
- Won't splinter or rot, never needs painting
- Cleans easily with soap and water



Adaptable Design

- Unique design delivers outstanding load capacity, functionality, and safety
- Variety of dock sections, boat/PWC lifts, and launches for kayaks
- Easily customizable design to make your perfect waterfront retreat



Flexible Flotation Technology

- Flotation chambers constructed for optimal strength and structural integrity
- Designed to provide additional stability on the water
- Dock sections adapt easily to changing water conditions and levels



Innovative Coupling

- Made of recycled materials
- Nuts and bolts made of heavy duty, rust resistant composite
- Strength and durability even in the harshest weather conditions



American Made

- Proudly for 30 years

For questions about features, operation/performance, parts, accessories, or installation, call your local EZ Dock dealer.

ided right into the
crete for bare feet.
or repainting or

d sizes, so they can
range of choices
ommercial or

ch can make them
ng the risk of damage.
ndently, making your
e. This bit of give has
ropical storms.

innovative couplings
d running in no time,
nd swimming.

A	204060	Baby Dock Section	Beige <input type="radio"/>	39" X 58-1/2" X 14"
	204060-EZGR		Grey <input type="radio"/>	
B	204010	40" Dock Section	Beige <input type="radio"/>	39" X 117" X 14"
	204010-EZGR		Grey <input type="radio"/>	
C	206010	60" Dock Section	Beige <input type="radio"/>	58-1/2" X 117"
	206010-EZGR		Grey <input type="radio"/>	
D	208010	80" Dock Section	Beige <input type="radio"/>	78" X 117" X 14"
	208010-EZGR		Grey <input type="radio"/>	
E	208008	100" Dock Section	Beige <input type="radio"/>	98" X 78" X 14"
	208008-EZGR		Grey <input type="radio"/>	
F	158010	80" Low Profile Dock Section	Beige <input type="radio"/>	78" X 117" X 7"
	158010-EZGR		Grey <input type="radio"/>	
G	260120	Half Hex Dock Section	Beige <input type="radio"/>	58-1/2" X 59" X 14"
	260120-EZGR		Grey <input type="radio"/>	
H	300503	Tri Dock Section	Beige <input type="radio"/>	58-1/8" X 58-1/8" X 14"
	300503-EZGR		Grey <input type="radio"/>	
I	301100	Coupler Set w/ Hardware	Black <input type="radio"/>	

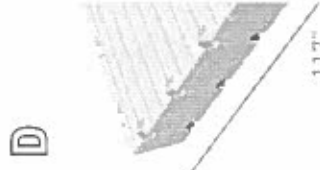
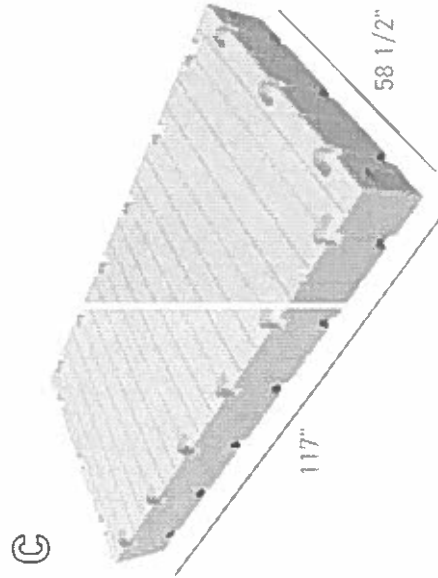
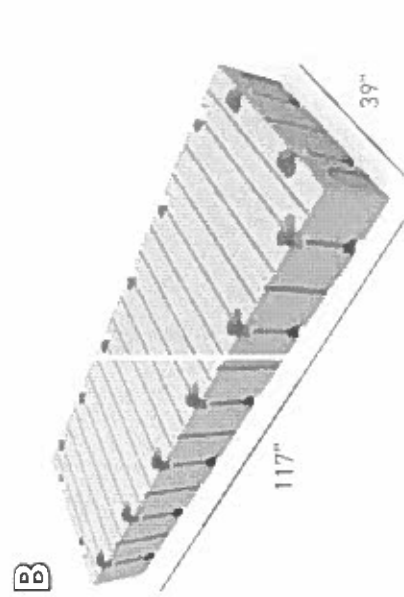

port, with no winching, cranking, pumping, or hoisting needed.

Flexibility
All EZ Ports can be linked together and easily adapted to other floating and fixed docks using our revolutionary EZ Port® coupler system with EZ Dock connectors.

Stability
Our proprietary flotation chamber and pylon design provides enhanced buoyancy and stability to reduce movement even in rough water and stormy conditions. EZ Port also provides plenty of space on the front and either side of the port to allow PWC users to find their footing comfortably.

Protection
EZ Port PWC lifts move with changing water levels, protecting personal watercraft from waves, wind, and the damage they can cause. Our personal watercraft ports are also covered by an industry-leading 8-year warranty.

Low maintenance and barefoot friendly
EZ Dock's polyethylene ports are durable and slip resistant. They won't splinter or rot and never need painting. They are easy to clean with a pressure washer or EPA-approved cleaning solutions.



156"

153"

shapes. The EZ Port MAX is one of the most flexible options available and can be customized to maximize slip spaces with tandem inlines that help you accommodate more PWC's per slip. Just configure the design that best suits your waterfront and adjust the design any time your needs change.

The EZ Port MAX is a flexible system designed for single, multiple, or inline ports to accommodate multiple PWC's.

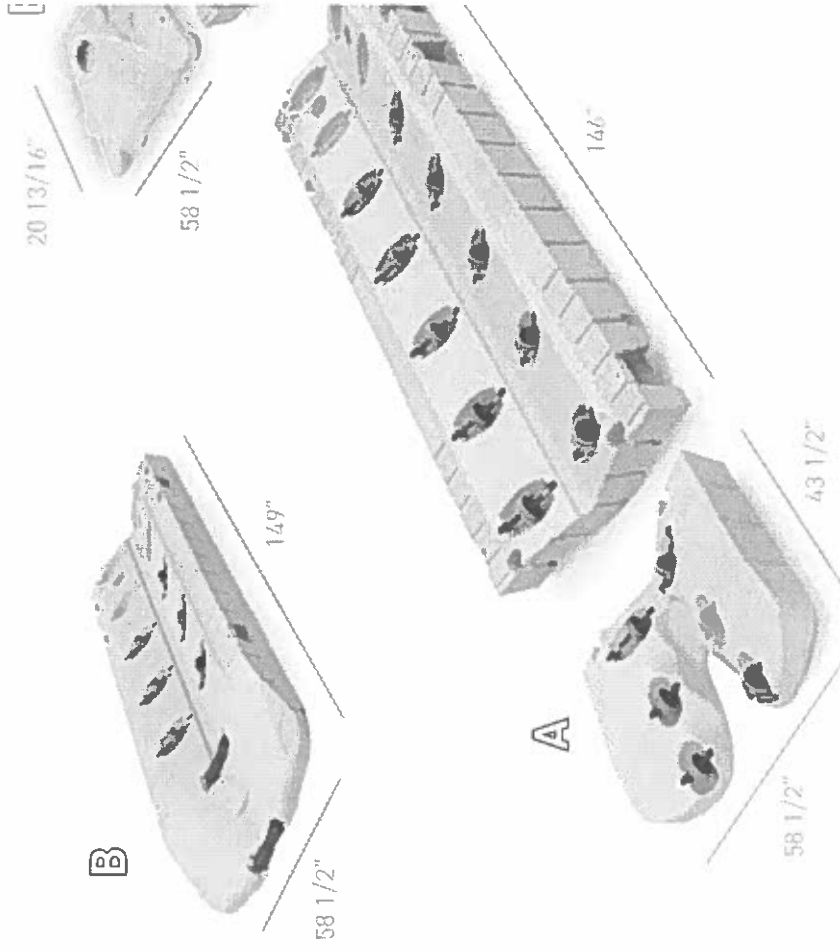

Model	Color	Size	Weight
EZ Port 280	Beige	156" x 78" x 14-5/8"	330 lbs.
	Grey		
EZ Port VXP	Beige	153" x 58-1/2" x 14-5/8"	325 lbs.
	Grey		
	Beige	149" x 58-1/2" x 17-5/8"	250 lbs.

Part #	Model	Color
206033EX	EZ Port MAX Easy-Lift Entry	Beige
206033EX-EZGR		Grey
206030PW	EZ Port MAX Entry	Beige
206030PW-EZGR		Grey
203031PW	EZ Port MAX Extension	Beige
203031PW-EZGR		Grey
206025B5		Beige

- Guide rails for easy access in and out of the water
- Launch rollers for easy movement of the watercraft
- Floating platform that adjusts to changing water levels

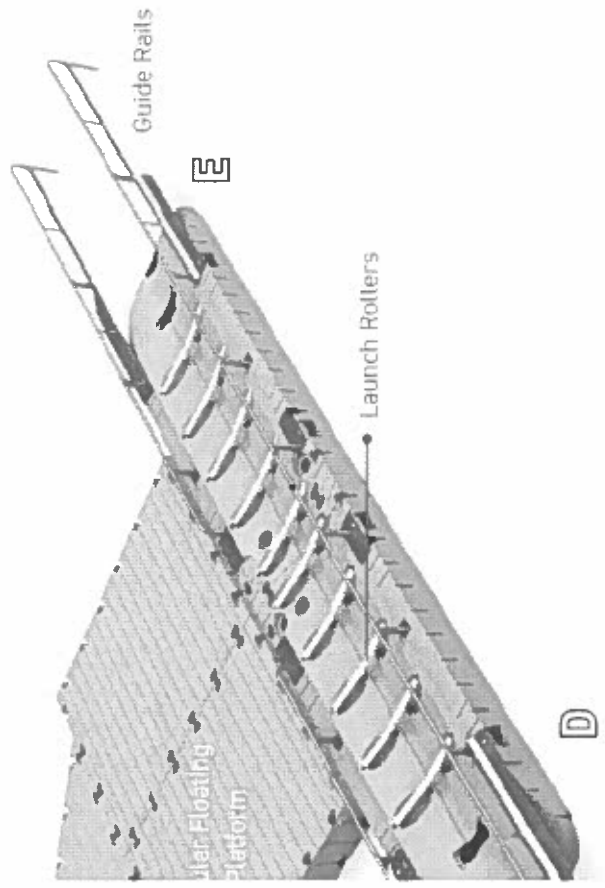

- Transfer slide board with two heights for differing watercraft sizes
- Railing system for slide board stabilization & support for easy movement

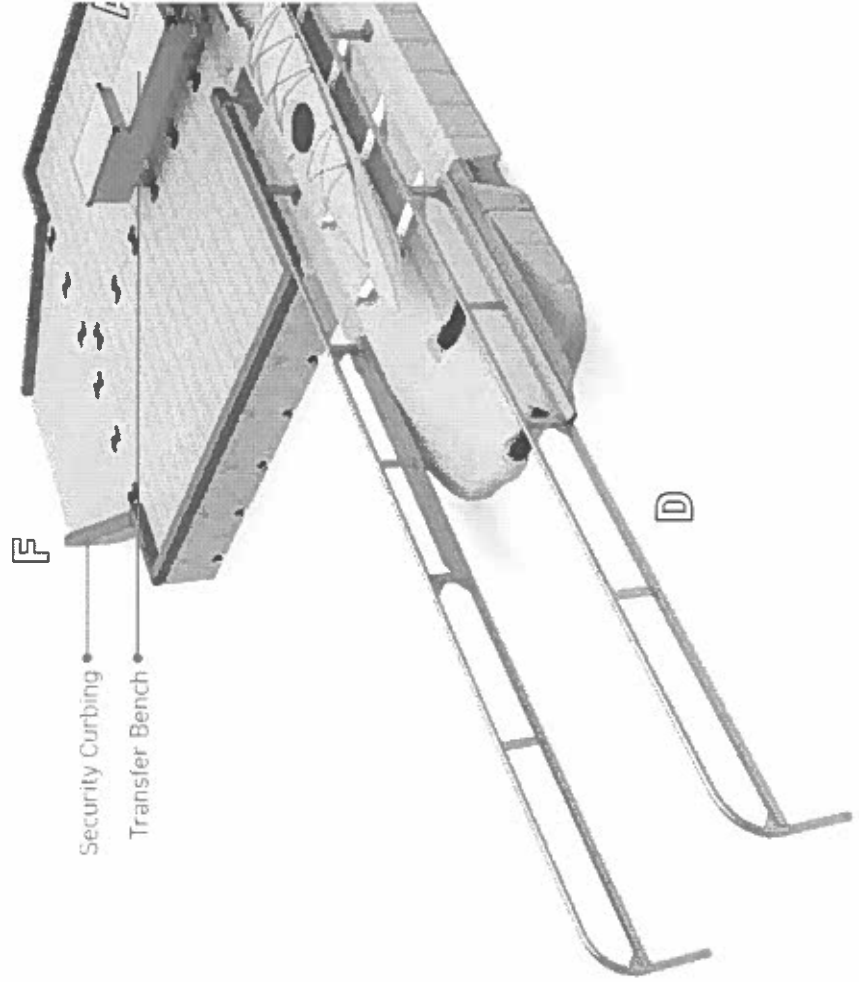

- Transfer slide board with two heights for differing watercraft sizes
- Railing system for slide board stabilization & support for easy movement

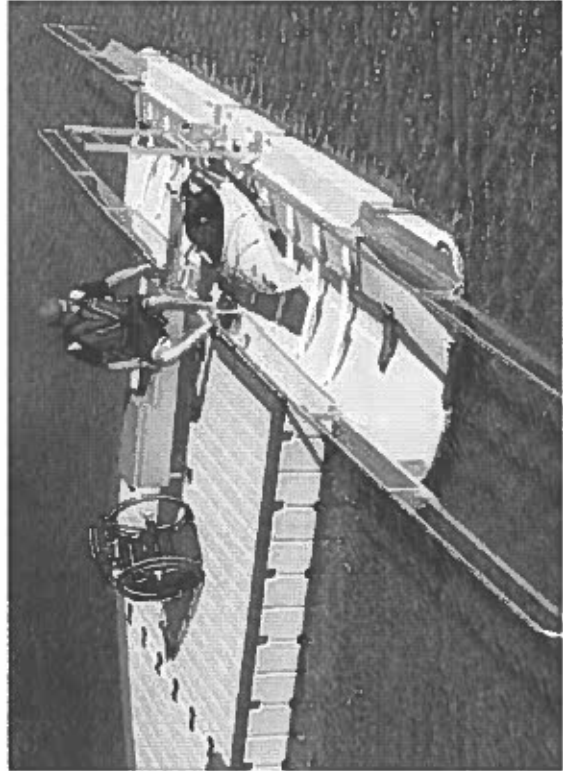

Part #	
5008900	A
1007575S	B
500901	C
500900L	D
500900R	E

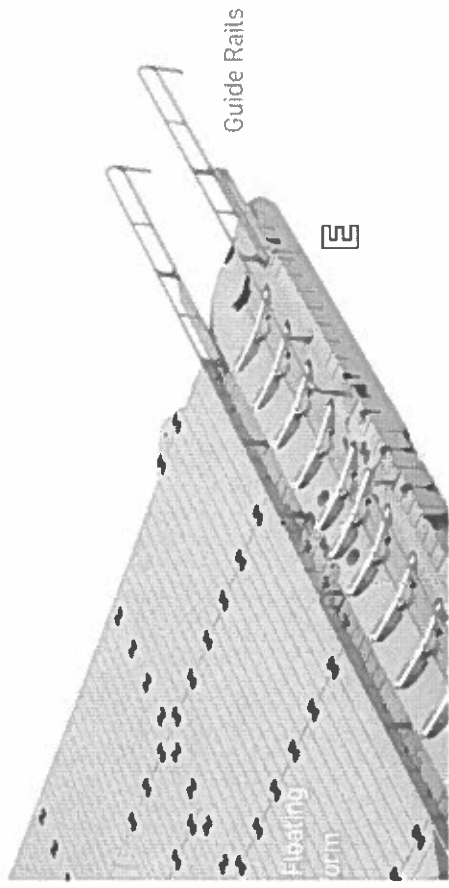

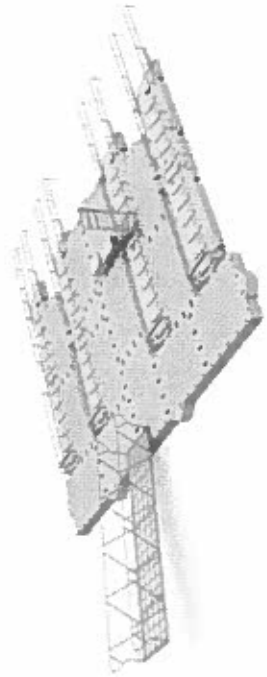

& Boat Slip



EZ Launch® One-way & Extra-Large Platform

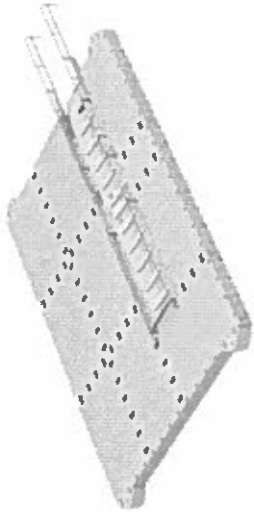

Bench,

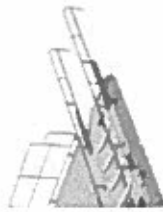

EZ Launch® Drive Thru with Large Platform

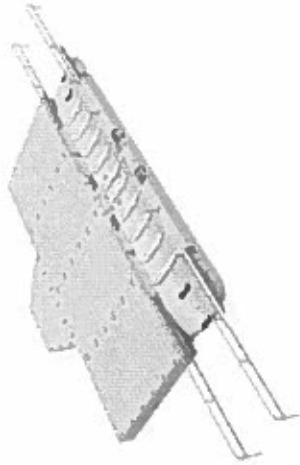

EZ Launch® Drive Thru with Small Platform



• Dock entry includes stairs, or y entry.

• Launch-assist paddle notches support easy entry/exit. V-shaped entry centers vessel.

• Engineered to connect with virtually any dock (EZ Dock or any other dock).

• Fits canoes, tandem kayaks, stand-up paddleboards, etc.

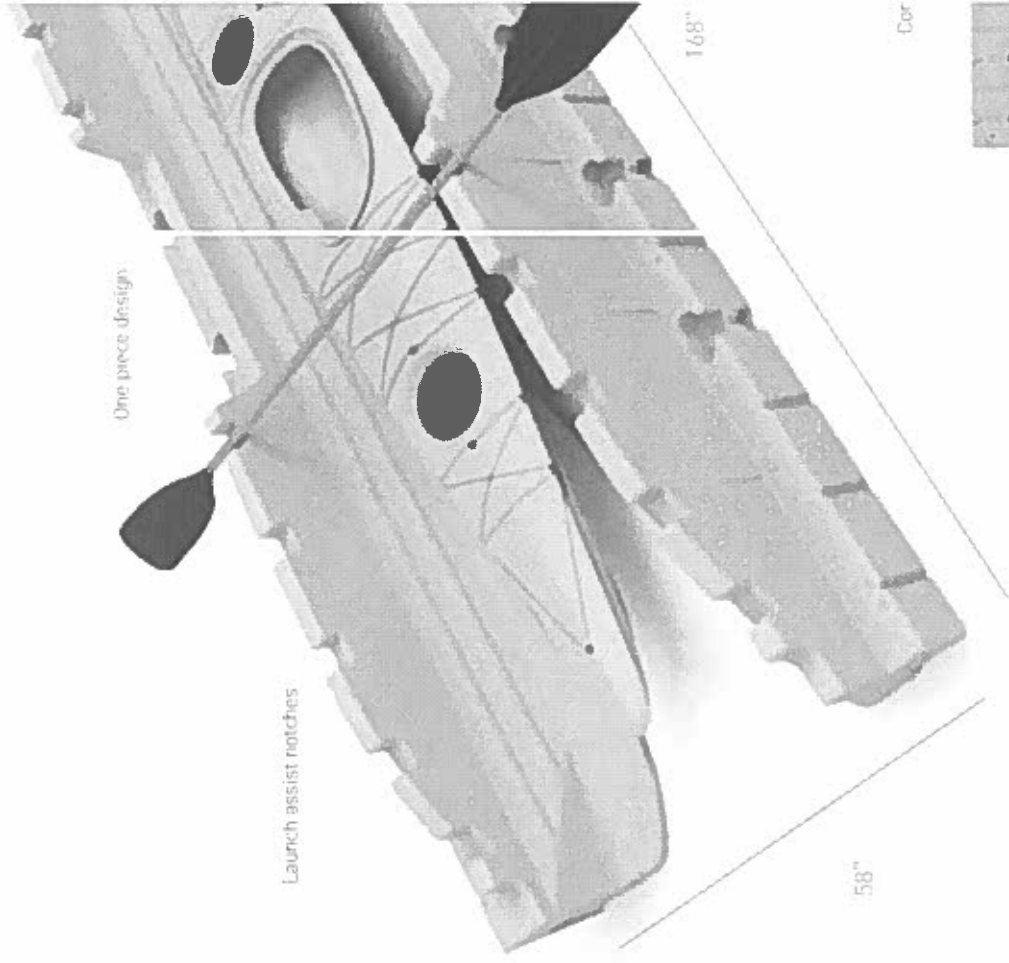

One piece design

Launch assist notches

168"

58"

Cor



Part #

200900

A 200900-EZGR

Model

EZ Launch for Kayaks

Color

B

C

Long (L) and Short(S) bunk options.

EZ BoatPort with Side Extensions 140 sf
BP3000-EZGR, BP3000

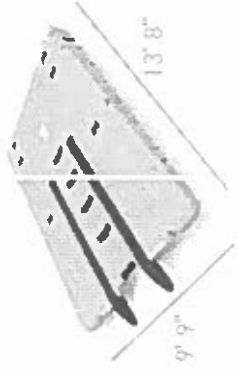

EZ BoatPort with Side Extensions & Large Platform 190 sf
BP3001-EZGR, BP3001

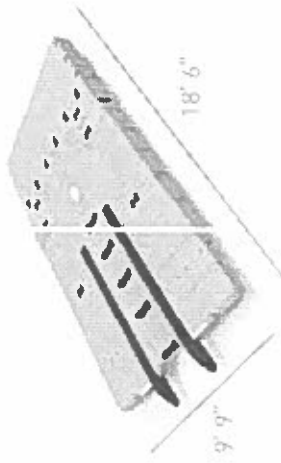

EZ BoatPort with Float Tank, Air Assist, & Large Platform 156 sf
BP4001-EZGR, BP4001

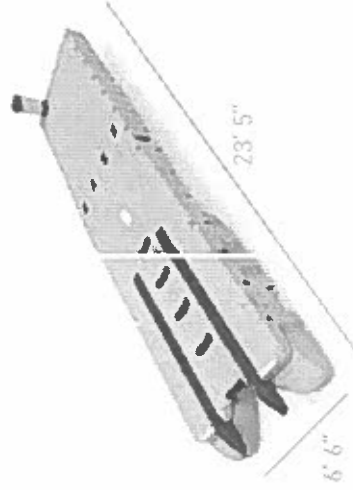

EZ BoatPort with Side Extensions, Float Tank, & Air Assist 205 sf
BP5000-EZGR, BP5000

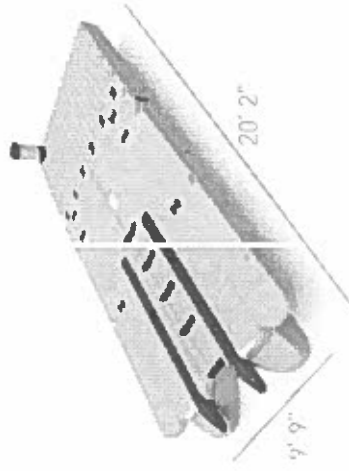

1 sizes

1 float tanks

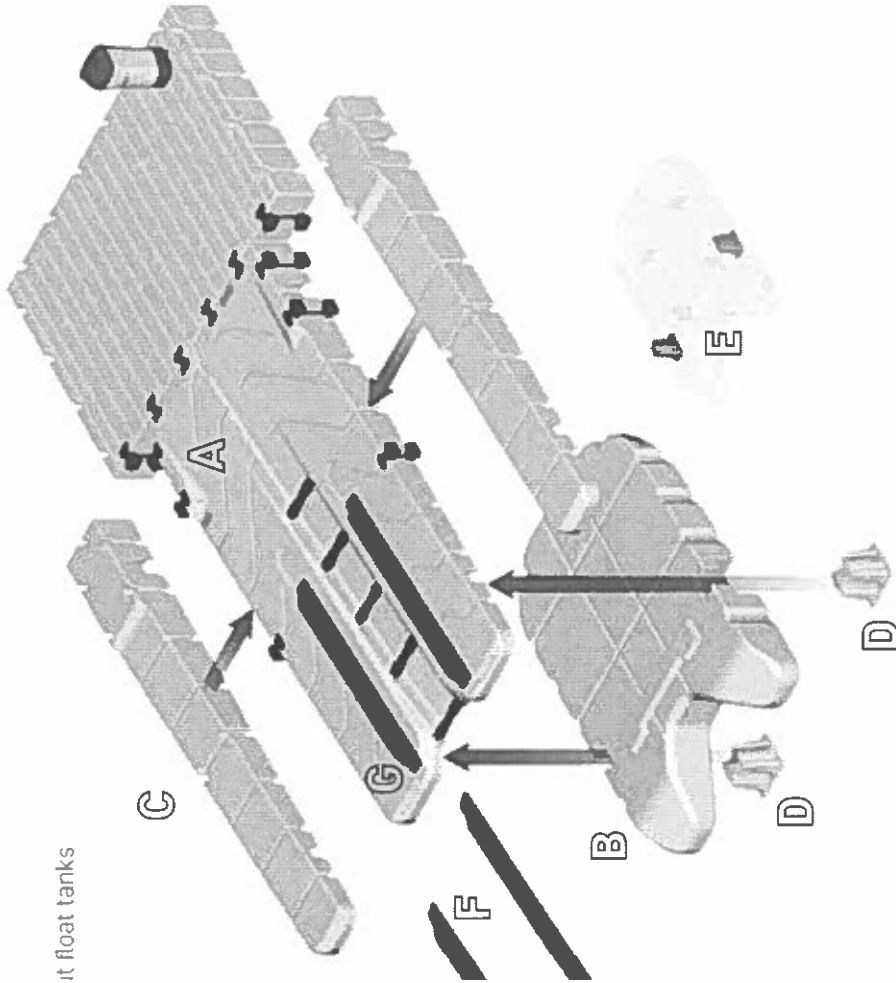

Color	Size	Weight	Floatation
Beige	164" x 78" x 14.5/8"	500 lbs.	2000 lbs.
Grey			
Beige	111" x 78" x 19.625"	240 lbs.	2000 lbs.
Grey			
Beige	164" x 20" x 14.625"	140 lbs.	500 lbs.
Grey			
Beige	13.5" x 7.5" x 12"	15 lbs.	N/A
Grey			
Beige	13.5" x 7.5" x 12"	7 lbs.	N/A
Grey			

AIR ASSIST PUMPS

Manual, 110VAC, Kit
600053
16" x 14" x 20"

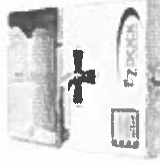

Remote, 110VAC, Kit
600052-EZGR, 600052
16" x 14" x 20"



ock anchoring products are made from long-lasting, durable materials that can help you select the anchoring system that's right for your location.

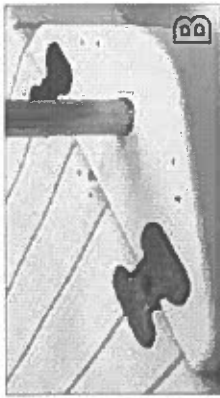

A
HEAVY-DUTY PIPE BRACKET
Heavy-duty polyethylene pipe bracket allows docks to adjust to changing water levels.



B
HEAVY DUTY PIPE BRACKET W/ INSERT
Heavy-duty polyethylene pipe bracket allows docks to adjust to changing water levels.



C
STIFF-ARM HEAVY DUTY BRACKET
Anchor to a shoreline abutment or to a shoreline post. Light duty also available.



D
POLY PIPE STAND-OFF BRACKET
Bracket attaches top of pipe to stationary docks. Fits pipe from 2.5" to 3.5" O.D.

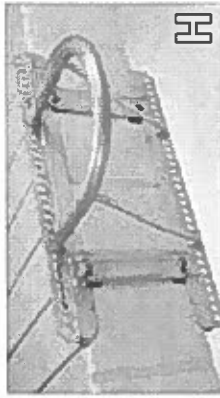

E
PILING BRACKET AND HOOPS
Pre-filled for hoops (sold separately) and includes nuts and connectors. SS hardware available.



F
DEADWEIGHT BRACKET
For tight-duty anchoring with chain and/or to attach 4" (10cm) x 4" (10cm) railing or mooring posts. Sold in pairs. Chain sold separately.

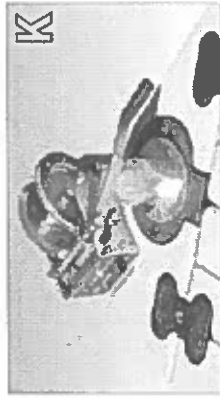

G
DEADWEIGHT WINCH INSERT
Deadweight insert and cable winch added to our polyethylene pipe bracket allows easy dock adjustment for water fluctuations. Cable sold separately.

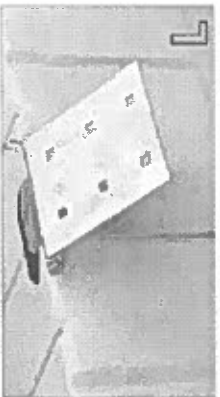

H
ADAPTOR HINGE
Reversible hinge allows EZ Port PWC lifts or EZ Dock sections to be attached to other floating docks.

Part #	Model
135250(-EZGR)	Standard Pipe Bracket
135350(-EZGR)	Heavy-Duty Pipe Bracket
215250(-EZGR)	Heavy-Duty Pipe Bracket with Insert
215350(-EZGR)	Stiff-Arm Bracket
210250(-EZGR)	I.D. post sleeve for stiff arm
210350(-EZGR)	Stiff-Arm Heavy Duty Bracket
100700	Poly Pipe Stand-Off Bracket
800095-15	Adjustable Piling Bracket (NEW)
800099	Piling Bracket (for hoops below)
580094	Hoop for Piling Bracket
1051000	Hoop for Piling Bracket
300810(-EZGR)	Hoop for Piling Bracket
100800	Hoop for Piling Bracket
100804	Hoop for Piling Bracket
100806	Hoop for Piling Bracket
100808	Hoop for Piling Bracket
100812	Hoop for Piling Bracket
100816	Hoop for Piling Bracket
100820	Hoop for Piling Bracket
100824	Hoop for Piling Bracket
100740	Deadweight Bracket Kit
100740SS	Deadweight Bracket Kit Stainless
215350	Bracket & Insert for 3.5" O.D. pipe
100725P	Deadweight insert for #210350 assem
100730	Deadweight winch insert
210350	Heavy Duty Dock Bracket for winch ins
100750	Adapter Hinge
100750SS	Adapter Hinge Stainless
100751	EZ Port Adapter Hinge

connectors to bolt it directly to the section you choose. It's that easy.



STORAGE BOX

Permanently mounted and constructed of weather-resistant materials, the EZ Dock Storage Box is a great place to store life jackets, towels, and other essential supplies.

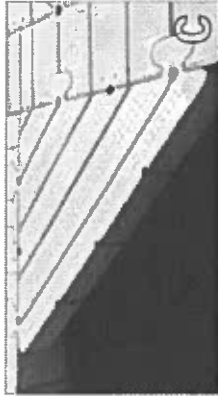

CORNER GUSSET

Polyethylene corner gusset adds deck surface and additional stability to dock fingers when needed. Gusset is 33.5" (85cm) wide, 6" (15cm) high.



TIE-DOWN CLEAT

Tie-down cleat (8") and other accessories attach to heavy-duty stainless-steel T-nuts molded in pairs around dock section perimeters.

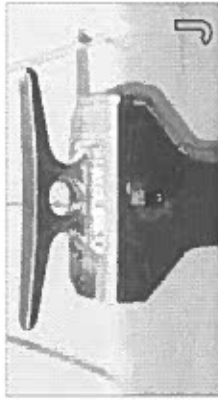

TIE-DOWN CLEAT

Tie-down cleat (10") and other accessories attach to heavy-duty stainless-steel T-nuts molded in pairs around dock section perimeters.

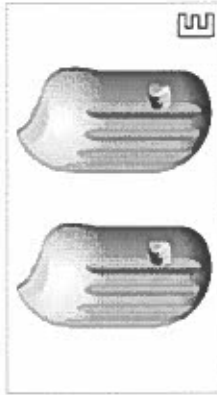

DOCK BUMPER

This dock bumper is designed to protect the boat gunwales and rub-rails. Dock bumper will attach to dock using embedded T-nuts.



POLY BENCH WITH ARM-RESTS

Redesigned brackets with 2" round, .25" aluminum tubing. Installs along any open 3-pocket span on an EZ Dock product.

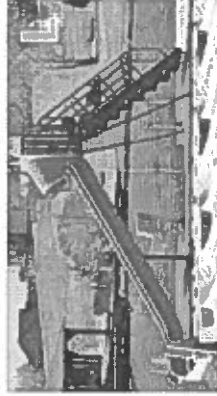

DOCK SLIDE

Utilizes rugged polyvinyl-coated steps, and a one-piece polyethylene bedway for a smooth ride. Installs with almost any EZ Dock* where water depth is more than 5'. (Requires use of (2) 80" dock sections.)

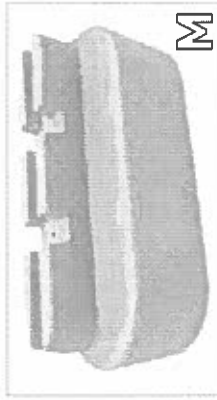

SUPPLEMENTAL FLOTATION POD

This float pod is designed to add 200lbs (91 kg) of flotation and is sized to fit under most dock pylon shapes.

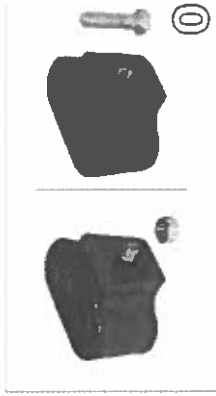

HARDWARE CONNECTORS (MIF)

For attaching various accessories. .625" SS bolts and nuts.

Part #	Model	Color
A 300760	Corner Storage Box w/Gusset	Beige
300760-EZGR		Grey
B 300750	Storage Box	Beige
300750-EZGR		Grey
C 300501	Corner Gusset	Beige
300501-EZGR		Grey
D 300260	Swim Ladder	Beige
300260-EZGR		Grey
E 300180	Dock Bumper	Beige
300180-EZGR		Grey
F 300970AL	Poly Bench with Arm-rests	Beige
300970AL-EZGR		Grey
300965AL		Beige
	Poly Bench without Arm-rests	Beige

Part #	Model
I 300100	8" Tie-d
J 300110	10" Tie-
302060	5' x 20"
302060-EZGR	
302020	20' x 20
302020-EZGR	
302030	20" Insi
302030-EZGR	
302040	20" Outs
302040-EZGR	
300600	Dock St
300600FG	
208110	Supplier
300110-EZGR	

and solar models (optional). Each boat lift is available with manual control (standard optional). The Aegis boat lift tank system is precision-molded with linear low-density weather conditions, and low water damage. The lift keeps the boat out of the water the hull of your boat. The frame is constructed from hot-dipped, galvanized steel and allows you to have easy access to your watercraft to eliminate difficult maintenance products and traditional dock systems. Through the use of our air assist pumps, the 7,000 lbs. in weight and 28 feet in length. The Aegis 7 Boat Lift features fully adjustable strength, ultra-high molecular weight (UHMW), polyethylene bearing surfaces.

Part #	Model
BL7000	Aegis 7 Boat Lift - VHULL
BL7000PT	Aegis 7 Boat Lift - PONTON
BL7000TT	Aegis 7 Boat Lift - TRITON
BL7000WB	Aegis 7 Boat Lift - WAKE BOAT

Dimensions 10'-12' Wide x 13' 8" Long

Lift Capacity Up to 7000 lbs.

Weight - 1000 lbs

of Tanks 2

Slip Width 10'-12'

Minimum Water Depth 5'

Boat Length Capacity Up to 28'

Tank Color Blue

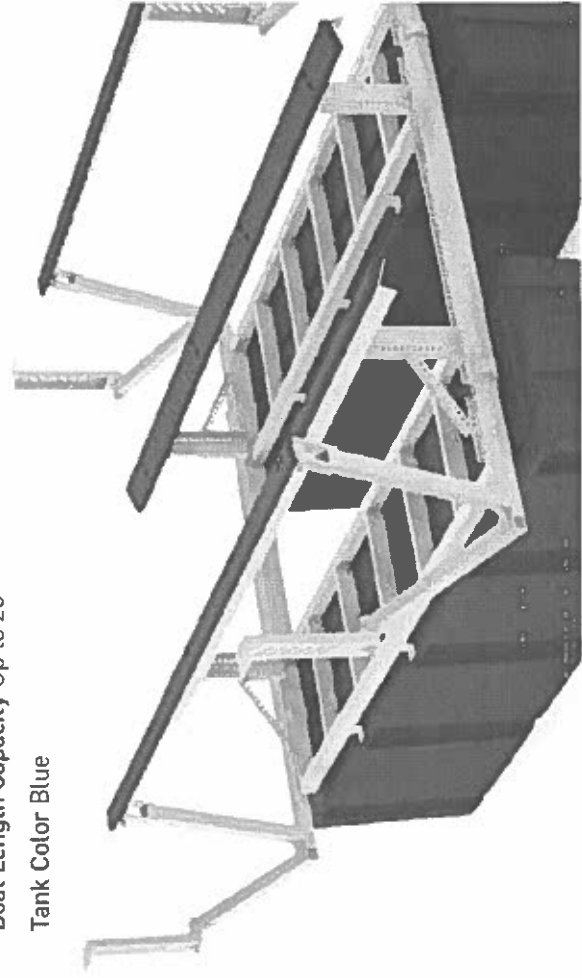

- FRG - Forest Green
- DBW - Brown
- BLU - Blue
- BEI - Beige
- AL - Aluminum, standard

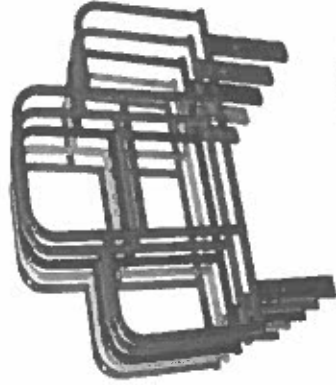
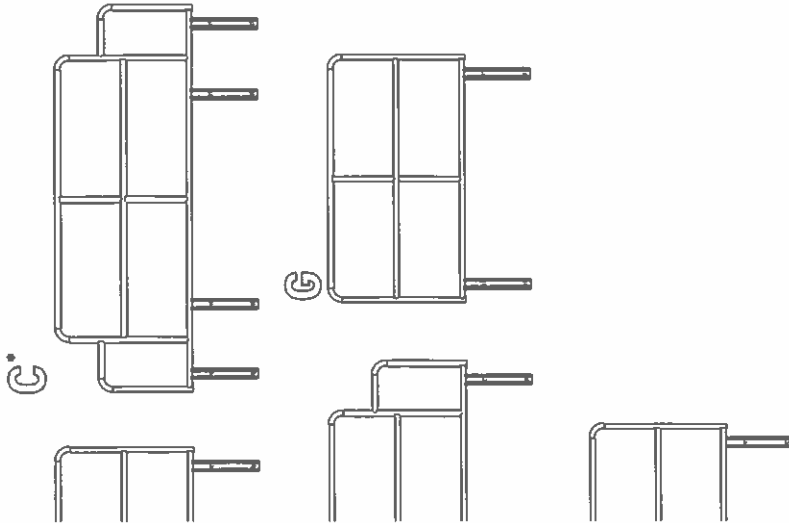

Part #	Model	Color	Size
100910AL	Style 910	Aluminum	10' (3m) Width
105910	Style 910	Alum. Powder Coat	10' (3m) Width
100911AL	Style 911	Aluminum	5' (1.5m) Width
105911	Style 911	Alum. Powder Coat	5' (1.5m) Width
100912AL	Style 912	Aluminum	10' (3m) Width
105912	Style 912	Alum. Powder Coat	10' (3m) Width
100915AL	Style 915	Aluminum	5' (1.5m) Width
105915	Style 915	Alum. Powder Coat	5' (1.5m) Width
100916AL	Style 916	Aluminum	5' (1.5m) Width
105916	Style 916	Alum. Powder Coat	5' (1.5m) Width
100917AL	Style 917	Aluminum	80" (2m) Width
105917	Style 917	Alum. Powder Coat	80" (2m) Width
100918AL	Style 918	Aluminum	80" (2m) Width
105919	Style 918	Alum. Powder Coat	80" (2m) Width
100919AL	Style 919	Aluminum	40" (1m) Width
105919	Style 919	Alum. Powder Coat	40" (1m) Width
100920AL	Style 920	Aluminum	40" (1m) Width
105920	Style 920	Alum. Powder Coat	40" (1m) Width

ing is required to keep them looking great for years to come. Constructed in
ates Organizations for Boating Access (SOBA), standard EZ Dock aluminum
ways offer continuous handrails extending 12 inches past the walking surface on
es. Aluminum gangways support 90 pounds per linear foot and a concentrated load
his latest version of the aluminum gangways is more rigid and yet adapts to all
achable handrails, making the shipping, handling, and assembly significantly less
d is specifically made for marine applications. It has a mill-finish and knurl pattern
in 3' and 5' widths, with length options from 8' to 32'. The gangways are compatible
s, and transition plates.

maximum stability and support as you walk to your dock or launch

, with welded aluminum walkway structure

ments designed to make it easier to link the shore, gangway, and dock together

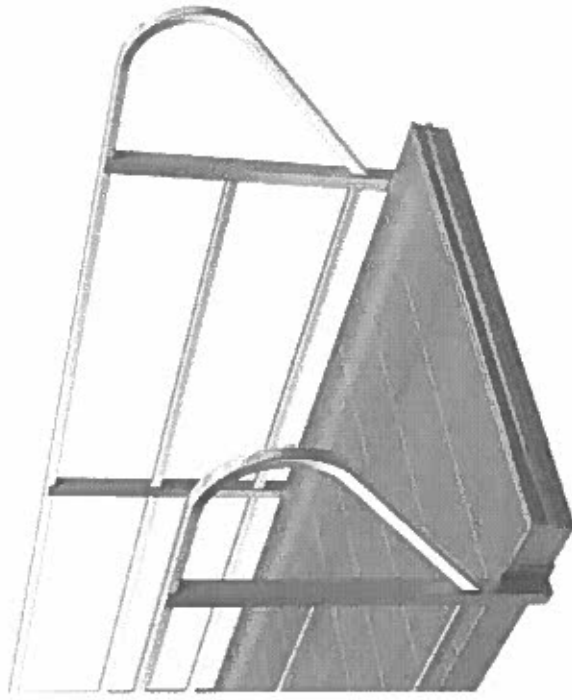

Molded Plastic Gangway
US Pat. 6912966

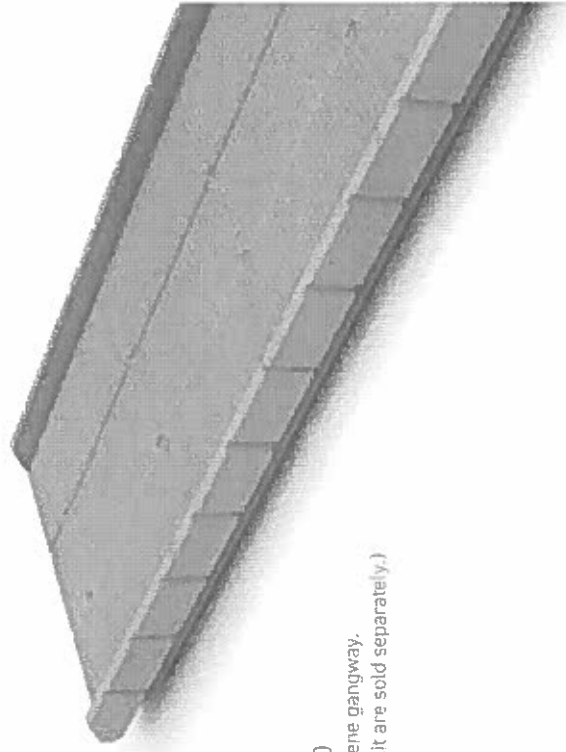

Gangway 404010
10' section polyethylene gangway.
(Railing and Roller Kit are sold separately.)

imum Decking, Detachable Aluminum Railing and Hardware

Description	Length	Width (Inside)	Width (Outside)	Weight
/hardware, railings, AL deck	8'	36"	41"	202
/hardware, railings, AL deck	12'	36"	41"	281
/hardware, railings, AL deck	16'	36"	41"	372
/hardware, railings, AL deck	20'	36"	41"	449
/hardware, railings, AL deck	24'	36"	41"	524
/hardware, railings, AL deck	28'	36"	41"	618
/hardware, railings, AL deck	32'	36"	41"	688

imum Decking, Detachable Aluminum Railing and Hardware

/hardware, railings, AL deck	8'	60"	65"	262
/hardware, railings, AL deck	12'	60"	65"	365
/hardware, railings, AL deck	16'	60"	65"	480



GANGWAY ROLLER KIT
300300, 300400, 300450
Gangway Roller Kit allows end of gangway
to adjust to changing water levels. PVC
and galvanized steel roller available for
3' and 5' widths.

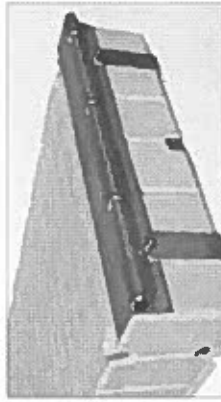

HINGE-TO-FLOAT
G200360, G200560
400410, 400460, 400480
Hinged bracket with hardware attaches
gangway to dock.

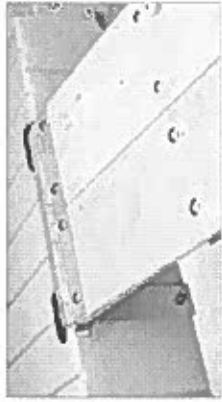
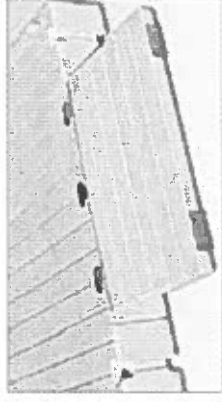

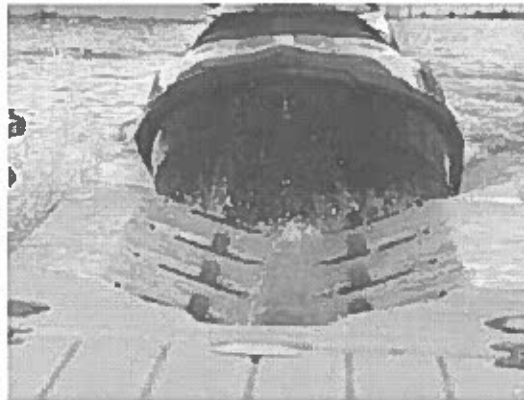
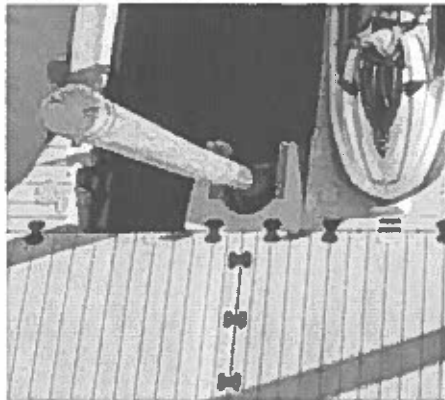
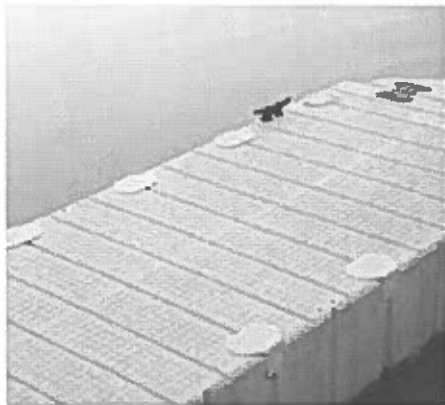

Proudly American made for 30 years.

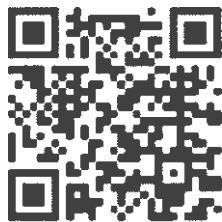

The EZ Dock global network of highly trained and knowledgeable dealers and distributors is ready to help. Our experienced team is standing by to help you choose a system that will maximize your space and suit your specific application.

Visit our website at ez-dock.com to create your perfect dock or to find your local EZ Dock dealer.

US/Canada	1-800-654-8168
Europe	+46 (0) 380 47 300
International	+1-417-235-2223

EZ Dock product is produced in our Monett, MO facility which is certified by Intertek for ISO 9001:2015 quality management system and ISO 14001: 2015 environmental management system. EZ Dock may introduce new colors, products, accessories, and options throughout the year. Specifications and products listed are subject to change without notice. Some products may be shown with additional or optional equipment not available through EZ Dock. Specifications may vary for international shipments. Please check with your local dealer for more information. EZ Dock is a product of the U.S.A.

EZ Dock, Inc | 878 HWY 60, Monett, MO 65708 | 417-235-2223 | 800-654-8168
© 2022 EZ Dock, Inc. All rights reserved.



Estimate

816-260-5113

justin@ezdockofthegreatplains.com

515 Airport Road Bismarck, ND 58504

Date	Estimate #
2/7/2023	4399

Name / Address	
Green Lake County Parks Attn: Scott Weir Green Lake, WI 54941	
Dock Location	
Customer Phone	920-295-4355

Rep	P.O. No.
JL	

Item	Description	Qty	Rate	Total
208010	80" X 10' DOCK SECTION	2	2,779.00	5,558.00T
300503	TRI-DOCK SECTION	2	1,005.00	2,010.00T
206010	60" X 10' DOCK SECTION	2	2,119.00	4,238.00T
500960R-ASY	KIT, EZ LAUNCH "One-Way" RIGHT w/PORTS	1	10,001.00	10,001.00T
100757SS	EZ LAUNCH ADJUSTABLE ADAPTER KIT DOCK TO EZ LAUNCH SS (1 PR)	1	713.00	713.00T
5008900	EZ LAUNCH ACCESSIBLE TRANSFER W/ SUPPORT GRAB RAIL & SIGN	1	6,205.00	6,205.00T
215250	PIPE BRACKET KIT HEAVY DUTY 2.5"	4	374.00	1,496.00T
116025	2-3/8" OD - 10 GAUGE X 16' L GALVANIZED PIPE	4	200.00	800.00T
100255	AUGER KIT FOR 2-3/8" OD PIPE AL	4	43.00	172.00T
D1RC2BK	2" Round Pipe Cap With Flat Top - Black	4	8.00	32.00T
301100	COUPLER SET W/ COMPOSITE ROD	26	72.00	1,872.00T
35116	DOCK CURBING PLASTIC 2-1/2" x 3-1/2" X 116" (no bolts)	8	260.00	2,080.00T
80530SS	3' FLATHEAD SCREWS FOR CURBING	48	6.00	288.00T
G200460	GANGWAY HINGE KIT, AL GANGWAY TO 60" DOCK	1	550.00	550.00T
ADA512	ADA GANGWAY AL 5'x12' W/ HANDRAILS, BEIGE THRUFLOW DECK	1	5,641.00	5,641.00T
G200550	GANGWAY TRANS. PLATE, 5'AL, W/ DIAMOND PLATE	1	1,499.00	1,499.00T
300300	GANGWAY ROLLER KIT FOR PVC PIPE	1	254.00	254.00T
105042	PIPE ROLLER 3" SCH80 PVC X 64" for 5ft AL GANGWAY	1	110.00	110.00T
	Pre-Subtotal			43,519.00
Freight	Freight / Delivery to Green Lake, WI		2,724.00	2,724.00T
Dock Labor	Dock Installation (Optional)	0	5,900.00	0.00
	Sales Tax		0.00%	0.00
			Total	\$46,243.00

MADE IN USA



Dock Live Load of 62.5 lbs/sqft
Low Profile Dock Live Load 30 lbs/sqft

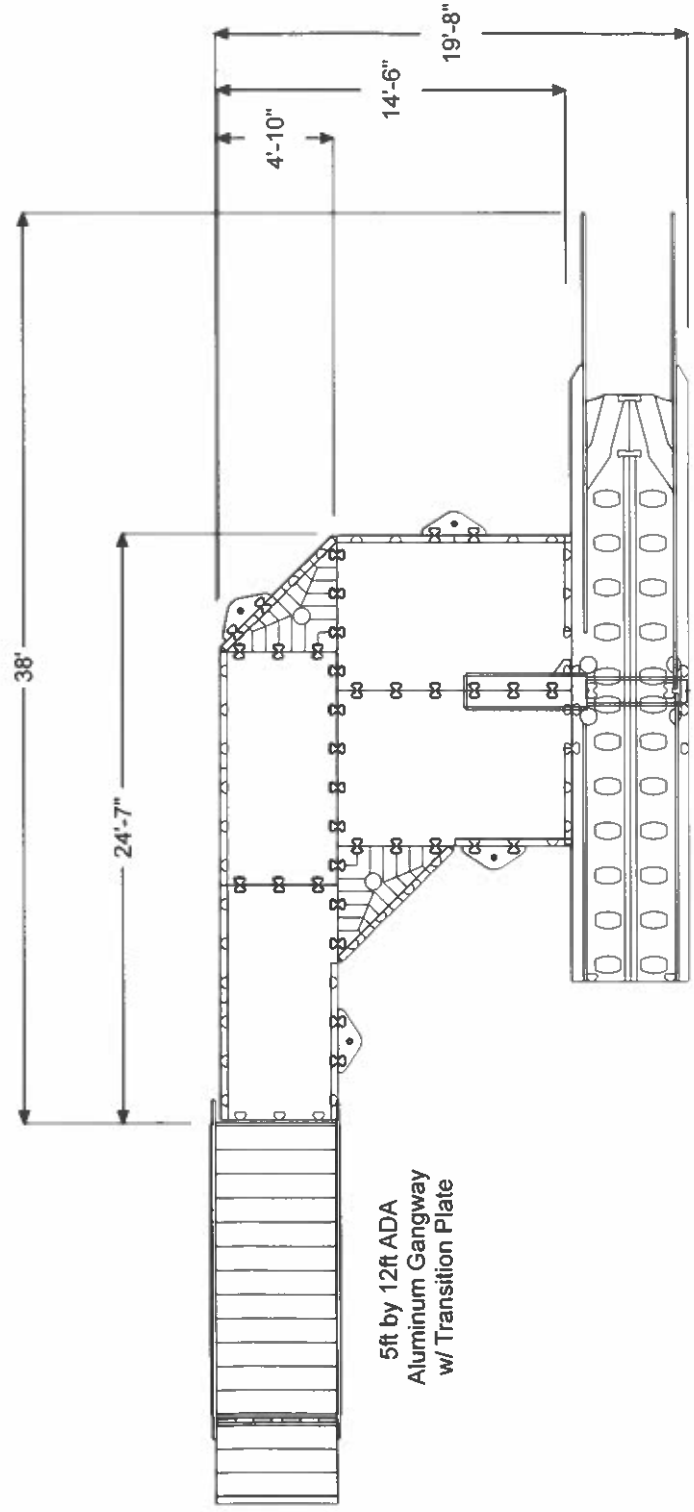

Project Name:
Green Lake County Park
Green Lake, WI

Distributor Name:
Justin Lance
EZ DOCK of the GREAT PLAINS
816-260-5113

Drawn by: Justin Lance
Date: 2/7/2023
DWG Name: ABC_4496479379

EZ Dock, Inc
878 East Highway 60
Monett, Missouri 65708
Phone: 1 (800) 654-8168
Fax: (417) 235-2232

General Notes:

1. This drawing does not reflect anchoring. Once sufficient information & completed Proposal Request Form concerning water and bottom conditions is received, anchoring may be detailed.
2. Note: It is the dock owner operator's responsibility to ascertain and comply with all applicable Federal, State, and local laws, ordinances and regulations, as well as all inspection, permitting and licensing requirements pertaining to the installation, application and use of EZ Dock products on the owner/operator's premises. EZ Dock, Inc. assumes no duty or responsibility with respect to the legality or compliance of the owner operator's chosen installation, application or use of EZ Dock products.
3. Reference EZ Dock Owner Manual for additional details.

NOTICE! Read EZ Dock Limited Warranty carefully. Among other things, EZ Dock does not warrant damages, failures or defects caused by unauthorized modification of EZ Dock Product, and/or unauthorized attachment to/of EZ Dock Product

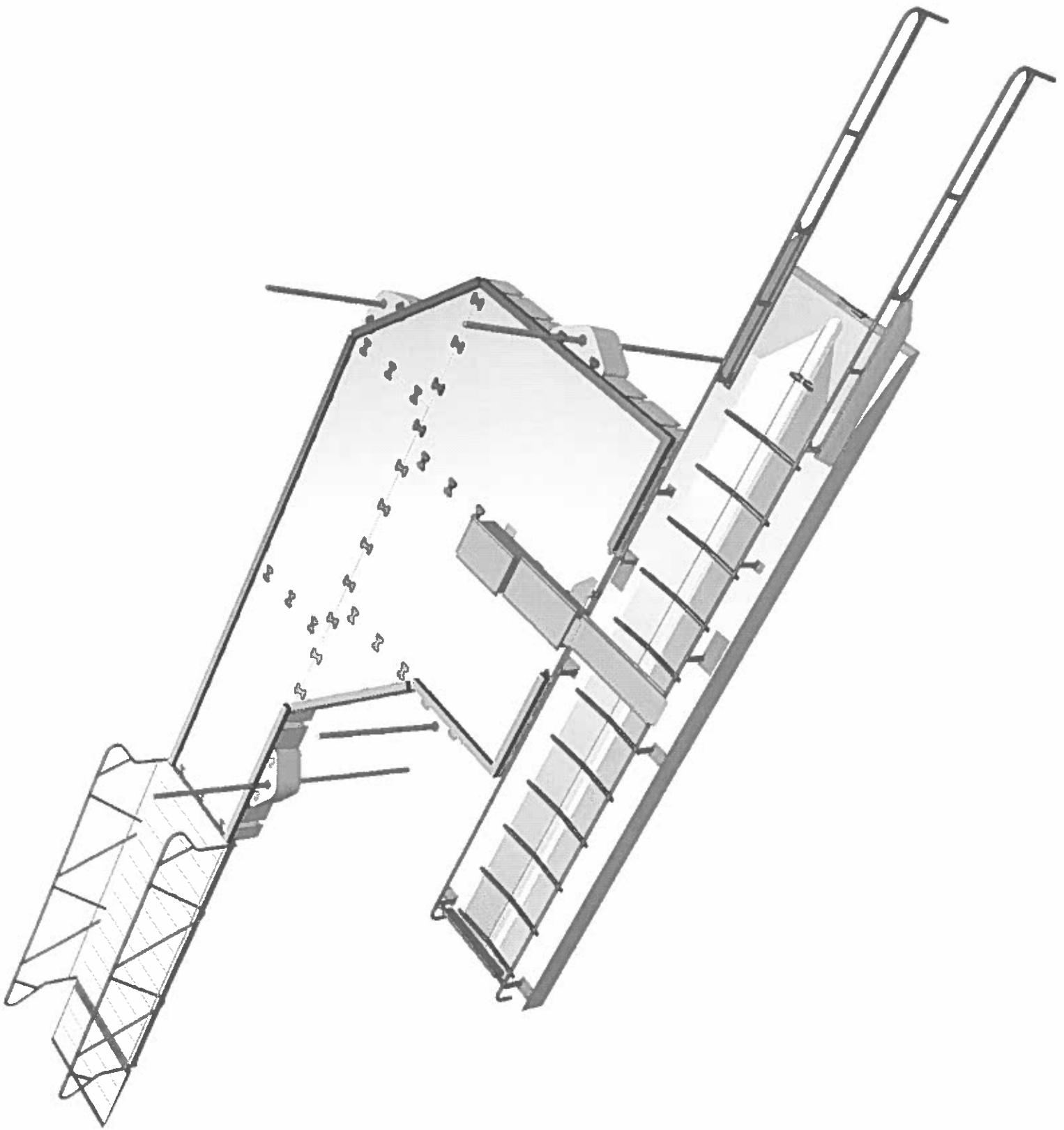

02/06/24
Parks Commission
Report
Parks & Recreation Department
Green Lake County

Zobel Park

3 dead trees removed upper park
Scheduled Maintenance performed
General Maintenance performed

Sunset Park

New information Board installed this last fall launch area
Scheduled Maintenance performed
General Maintenance performed

Twin Lake Park

Scheduled Maintenance performed
General Maintenance performed

Sunset Valley Park

Scheduled Maintenance performed
General Maintenance performed

Dodge Memorial Park

New information board install this last fall launch area
Scheduled Maintenance performed
General Maintenance performed

Lake Maria

Scheduled Maintenance performed
General Maintenance performed

Kingston Park

2 large dead ash trees removed by pavilion area along with trimming of other overhanging limbs
Scheduled Maintenance performed
General Maintenance performed

Mascoutin Valley State Trail

Scheduled Maintenance performed
General Maintenance Performed

Lauries Trail

Scheduled Maintenance performed
General Maintenance performed

Request for estimate cost ADA Kyak launch

\$38,000.00-49,000.00 for EZ Dock ADA Kyak launch we have had as presented 2 other meetings we have had only received 2 replies on this request one is from Bismark , ND, and the other is Cove Marine, Princeton, Wi. They have not given a firm estimate but a ball park figure as stated above. As stated before the are no other local area business that deal with this type od ADA Kyak launch system that we are requesting.

Submitted by:



Scott A. Weir
Maintenance Director/Parks & Recreation Director
Green Lake County